

Magnetic Contactors and Starters

FC and FW series

Magnetic contactors FC series

■ Description

FUJI FC series contactors are designed for use in consumer products and light industrial machinery and equipment. They are recommended for applications which call for economy, easy handling and reliability.

Typical applications include air conditioners, show cases, industrial washing machines, heaters, pumps, fans, compressors, dryers and vending machines. They are available in sizes ranging from FC-0UL to 4UL and up to 30kW at 440 Volts AC.

■ Features

- Small size, light weight
- Budget priced
- Long service life
Electrical life expectancy: 250,000 operations. Good for 7 years service if they are operated 100 times a day.
- Scrubbing action
The contacts are self-cleaning by a scrubbing action during operation and are made of a silver alloy.
- Highly reliable operating coil
Pick-up voltage
75% of rated voltage
- Self-lifting terminals
Easy to wire

■ Construction

FC-0UL, 0SUL

- Their small size permits them to be mounted in positions where space is limited and they can be mounted in a variety of directions.
- The standard terminals are screw-type. Printed board type and tab terminals are also available.

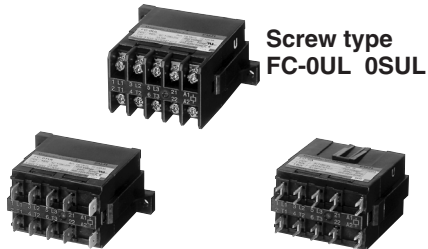

Tab terminal type
FC-0TUL

Printed board type
FC-0A

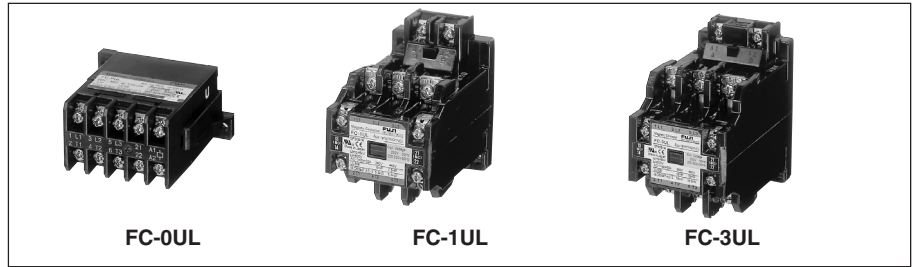

- The contact section is housed inside the molded frame and is totally enclosed. The dust-tight construction keeps contact performance at a high level and results in a long trouble-free service life.

FC-1UL to 4UL

- FUJI self-lifting terminals make connection work simple.
- Their free floating design results in quiet operation and eliminates chattering and bouncing.
- The magnetic yokes have been given a rust preventing treatment.
- Coil power consumption is low.

■ Ordering information

Specify the following:

1. Ordering code
2. Operating coil voltage code
3. Auxiliary contact arrangement:
In the case of type FC-0UL, 0A and 0TUL, specify the contact arrangement.

■ Types and ratings (IEC60947-4-1)

Motor capacity (kW) AC-3 3-phase		Operational current (A) AC-3 3-phase		Operational current (A) AC-1 *2	Auxiliary contact		Non-reversing Open	
200V	380V	200V	380V		NO	NC	Type	Ordering code
3	2.5	12	6	20	1	—	FC-0UL	SF12B1A-■10
3	2.5	12	6	20	—	1	FC-0UL	SF12B1A-■01
3.5	4.5	15	10	20	1	—	FC-0SUL	SF15B1A-■10
3.5	4.5	15	10	20	—	1	FC-0SUL	SF15B1A-■01
5.5	5.5	20	13	30	1	1*1	FC-1UL	SF20B1A-■11
7.5	7.5	27	18	30	1	1*1	FC-1SUL	SF26B1A-■11
11	11	40	26	45	1	1*1	FC-2SUL	SF38B1A-■11
15	18.5	52	40	60	1	1*1	FC-3UL	SF50B1A-■11
18.5	30	65	65	80	1	1*1	FC-4UL	SF65B1A-■11
1.5	—	8	—	8	1	—	FC-0A	SF08BBA-■10
1.5	—	8	—	8	—	1	FC-0A	SF08BBA-■01
3	2.5	12	6	20	1	—	FC-0TUL	SF12B3A-■10
3	2.5	12	6	20	—	1	FC-0TUL	SF12B3A-■01
3.5	4.5	15	10	20	1	—	FC-0STUL	SF15B3A-■10
3.5	4.5	15	10	20	—	1	FC-0STUL	SF15B3A-■01
3	2.5	12	6	20	1	—	FC-0/GUL	SF12B1G-■10
3	2.5	12	6	20	—	1	FC-0/GUL	SF12B1G-■01
3.5	4.5	15	10	20	1	—	FC-0S/GUL	SF15B1G-■10
3.5	4.5	15	10	20	—	1	FC-0S/GUL	SF15B1G-■01
3	2.5	12	6	20	1	—	FC-0T/GUL	SF12B3G-■10
3	2.5	12	6	20	—	1	FC-0T/GUL	SF12B3G-■01
3.5	4.5	15	10	20	1	—	FC-0ST/GUL	SF15B3G-■10
3.5	4.5	15	10	20	—	1	FC-0ST/GUL	SF15B3G-■01
1.5	—	8	—	8	1	—	FC-0A/G	SF08BBG-■10
1.5	—	8	—	8	—	1	FC-0A/G	SF08BBG-■01

Notes: *1 Auxiliary contact arrangement 2NO or 2NC is available.

Cable connection: FC-0A: P. C. board
FC-0TUL, 0STUL: With flat connection tabs
Other types: With screw-type terminals

*2 Thermal current (A)

■: Coil voltage code, see page 01/91.

■ Ordering code system

● Contactor

S F 3 5 B 1 A — E 2 2
① ② ③ ④ ⑤ ⑥ ⑧ ⑨ ⑩

① Product category

Description	Code
Contactors and starters	S

② Series category

Description	Code
F series	F

③④ Frame size

Frame size	Code	
	③	④
0, 0T	1	2
0A	0	8
0S, 0ST	1	5
1	2	0
1S	2	6
2S	3	5
3	5	0
4	6	5

⑤ Version

Description	Code
<u>Non-reversing, open</u>	
Contactors	1
Standard	T
With tab terminal	
Starters	A
Standard	
<u>Non-reversing, enclosed</u>	
Standard	C
With ON-OFF pushbutton (plastic enclosure)	P
With ON-OFF pushbutton (steel enclosure)	S
With ON-OFF pushbutton and lamp (plastic enclosure)	K

⑥ Coil specification

Description	Code
AC operating coil	A
DC operating coil	G

⑦ Type of thermal overload relay

Description	No. of element	Code
Standard	2, 3	N
Quick operating	3	S
Open-phase protection	3	E

● Starter

S F 3 5 B A A N — E 2 2 T B D
① ② ③ ④ ⑤ ⑥ ⑦ ⑧ ⑨ ⑩ ⑪ ⑫

⑧ Coil voltage

Operating coil voltage		Code
50Hz	60Hz	
24V	24 — 26V	E
48V	48 — 52V	F
100V	100 — 110V	1
100 — 110V	110 — 120V	H
110 — 120V	120 — 130V	K
200V	200 — 220V	2
200 — 220V	220 — 240V	M
220 — 240V	240 — 260V	P
346 — 380V	380 — 420V	S
380 — 400V	400 — 440V	4
415 — 440V	440 — 480V	T

● DC coil

Operating coil voltage	Code
24V DC	E
48V DC	F
60V DC	G
100V DC	1
110V DC	H
200V DC	2
220V DC	M

⑩ Thermal overload relay ampere setting range

Ampere setting range (A)	Code	Ampere setting range (A)	Code	Ampere setting range (A)	Code
0.1 — 0.15	TA	1.4 — 2.2	TM	7 — 11	TV
0.15 — 0.24	TC	1.7 — 2.6	TN	8 — 16	TV
0.24 — 0.36	TE	2.2 — 3.4	TP	9 — 13	TW
0.36 — 0.54	TG			12 — 18	TX
				13 — 20	TA*1
				18 — 26	TB
				20 — 26	TC*2
0.48 — 0.72	TH	2.8 — 4.2	TR	24 — 36	TE
0.64 — 0.96	TJ	4 — 6	TS	28 — 40	TF
0.8 — 1.2	TK	5 — 8	TT	34 — 50	TG
0.95 — 1.45	TL	6 — 9	TU	45 — 67	TJ

Note: *1 For FW-1S: X

*2 For FW-1S: Y

⑫ No. of heater element

Description	Code
2-element	Blank
3-element	D

**Non-reversing motor starters
FW series**

Up to 30kW 440 Volts 3-phase

Description

The FUJI FW-series starters are primarily designed for domestic and light industrial use, and can be expected to have a service life of over seven years under conditions where they are operated over 100 times a day. Typical applications are air conditioners, industrial washing machines, boiler and other pumps, fans, compressors, dryers.

The FC contactor can be supplied separately. They are simple, compact and reasonably priced, yet highly efficient and dependable. The thermal overload relay is fitted with elements that compensate for changes in ambient temperature, so stabilizing operations in spite of the season.

Note: In case of F series, contacts and operating coil cannot be replaced at site.

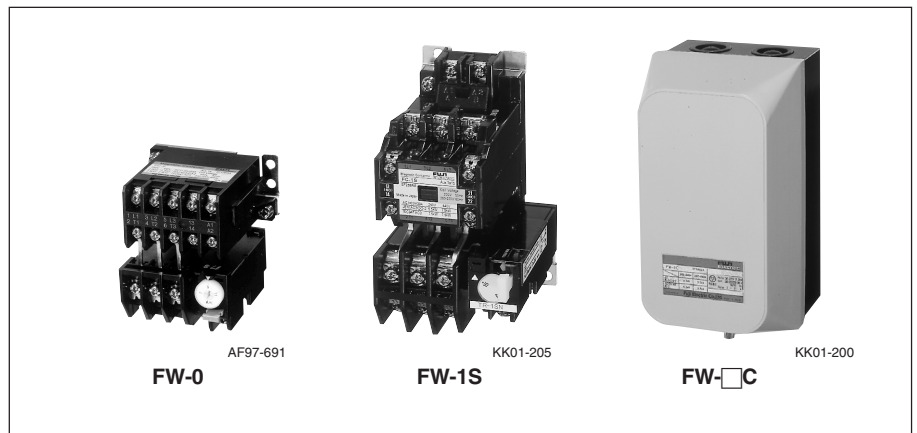

Ordering information

Specify the following:

1. Ordering code
2. Operating coil voltage code
3. Overload relay setting range code

Thermal overload relay:

See page 01/95.

Types and ratings

Motor capacity (kW)		Operational current (A)		Aux. contact		Open		Enclosed		Combined thermal overload relay
3-phase		3-phase		NO	NC	3-element Type	Ordering code	3-element Type	Ordering code	Type
200V	380V	200V	380V							
3	2.5	12	6	1	—*1	FW-0/3H	SF12BAAN-■10T□D	FW-0C/3H	SF12BCAN-■10T□D	TR-0/3
3.5	4.5	15	10	1	—*1	FW-0S/3H	SF20BAAN-■10T□D	FW-0SC/3H	SF20BCAN-■10T□D	TR-0/3
5.5	5.5	20	13	1	1*2	FW-1/3H	SF26BAAN-■11T□D	FW-1C/3H	SF26BCAN-■11T□D	RCa3737-1CNF/3
7.5	7.5	27	18	1	1*2	FW-1S/3H	SF27BAAN-■11T□D	FW-1SC/3H	SF27BCAN-■11T□D	TR-1SN/3
11	11	40	26	1	1*2	FW-2S/3H	SF35BAAN-■11T□D	FW-2SC/3H	SF35BCAN-■11T□D	TR-2NF/3
15	18.5	52	40	1	1*2	FW-3/3H	SF50BAAN-■11T□D	FW-3C/3H	SF50BCAN-■11T□D	TR-2NF/3
18.5	30	65	65	1	1*2	FW-4/3H	SF65BAAN-■11T□D	FW-4C/3H	SF65BCAN-■11T□D	TR-3N/3

Notes: *1 Auxiliary contact arrangement 1NC is available.
*2 Auxiliary contact arrangement 2NO or 2NC is available.
Conforming to IEC 60947-4-1 AC-3.

■: Coil voltage code, see page 01/91.
□: Thermal overload relay ampere setting range code, see page 01/91.

Coil ratings

Frame size	Power consumption (max.)		Voltage and frequency *
	Inrush (VA)	Sealed (VA)	
0, 0S	23	6	200V AC 50Hz
1, 1S	75	11	
2S	125	14	
3	125	14	
4	200	14.3	

Notes: * Other voltages between 24V and 440V AC are available.
DC operated type FC-0/G and FC-0T/G are also available.
Coil voltage: 24, 48, 60, 100, 120, 200, 210 and 220V DC

Wiring example

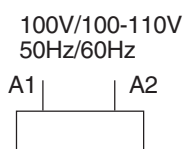

Performance data

Frame size	Making & breaking capacity	Operating cycles per hour	Durability (operations)	
			Electrical	Mechanical
0, 0S, 1, 1S	10 × Ie	600	250,000	1,000,000
2S, 3, 4	10 × Ie	600	250,000	1,000,000

Ie: Rated operational current (Amps).

Auxiliary contact ratings

Frame size	Rated thermal current (A)	Voltage (V AC)	Making & breaking capacity (A)	Rated operational current (A)	
				Inductive (cosφ=0.65)	Resistive (cosφ=0.95)
0, 0S	8	200-240	40	4	8
		380-440	20	2	8
1, 1S, 2S	10	200-240	60	6	10
		380-440	60	6	10

Magnetic Contactors and Starters

FC and FW series

■ Dimensions, mm
● Open type
FW-0/3H, FW-0S/3H

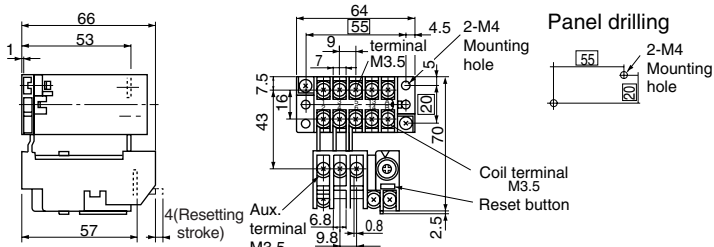

Mass: 0.29kg (with 3-thermal element)

● Enclosed type
FW-0C, 0SC, 1C

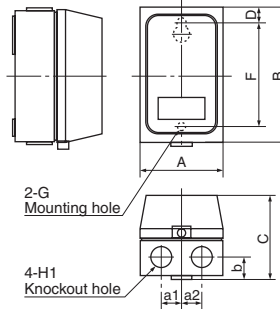

FW-1/3H, FW-1S/3H, 2S/3H, 3/3H, 4/3H

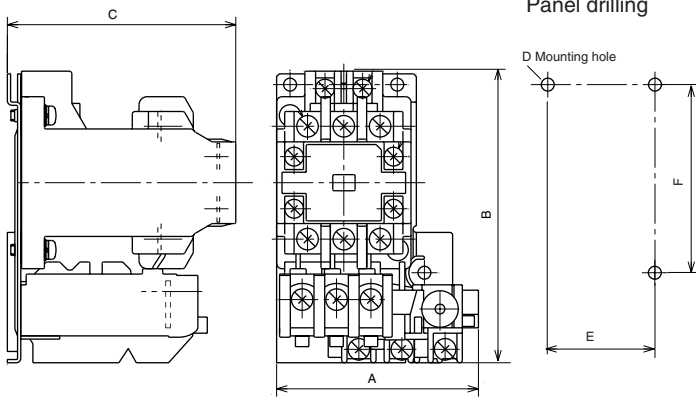

Type	A	B	C	D	E	F	Mass (kg)
FW-1/3H	75	108.5	85	2-M4	50	70	0.49
FW-1S/3H	68	121	90	2-M4	40	110	0.55
FW-2S/3H	78	138.5	91.5	2-M4	45	70	0.71
FW-3/3H	78	138.5	91.5	2-M4	45	70	0.71
FW-4/3H	90	175	109	3-M5	75	160	1.3

Mass: With 3-thermal element

Dimensions for reference only. Confirm before construction begins.

FW-1SC, 2SC, 3C, 4C

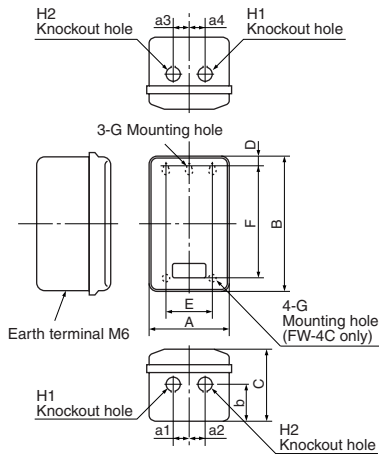

Type	A	B	C	D	E	F	G
FW-0C, 0SC*	71	120	79	15	-	90	ø5.3
FW-1C	94	166	95	15.5	-	135	ø5.5
FW-1SC	120	195	115	21.5	80	150	ø7
FW-2SC, 3C	130	230	124	20	80	190	ø7
FW-4C	175	320	145	35	110	250	ø7

Type	H1	H2	a1	a2	a3	a4	b	Mass(kg)
FW-0C, 0SC*	ø17	-	17.5	17.5	17.5	17.5	20	0.25
FW-1C	ø22	-	20	20	20	20	24	0.7
FW-1SC	ø22	ø22	22.5	22.5	20	20	35	1.5
FW-2SC, 3C	ø28	ø28	27	27	20	20	52	2
FW-4C	ø35	ø28	15	35	35	15	70	3.7

Note: * The enclosure dimensions given here are based on a "TR-0 thermal overload relay and 2-elements" being incorporated in the case. The temperature rise inside the enclosure may sometimes become a problem if a 3-element is used instead of a 2-element. In this case the FW-0P (Enclosure with pushbuttons) is recommended.

■ Wiring diagrams
FW-0/3H, 0S/3H

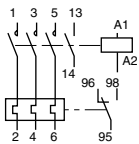

FW-1S/3H to 4/3H

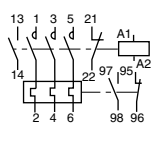

FW-1/3H

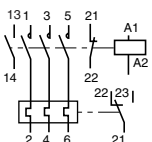

Example
FW-2S/3H

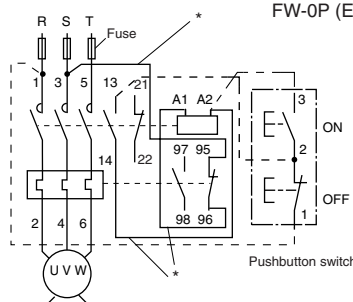

Note: * Open type: Wirings from 3 to 95, A2 to 14 and A1 to 96 are not connected at factory. Connect the wires at site.

Thermal overload relays for FW series

Type*1 (3-element)	Setting current (3-element)*1		Reset		Contact
	Range (A)	Ordering code	Range (A)	Ordering code	
TR-0/3	0.24–0.36	TB13DW-E	4–6	TB13DW-S	Manual *2 SPDT
	0.48–0.72	TB13DW-H	5–8	TB13DW-T	
	0.8–1.2	TB13DW-K	6–9	TB13DW-U	
	0.95–1.45	TB13DW-L	7–11	TB13DW-V	
	1.4–2.2	TB13DW-M	9–13	TB13DW-W	
	1.7–2.6	TB13DW-N			
	2.8–4.2	TB13DW-R			
RCa3737-1CNF/3	4–8	TC20DF-S			Manual
	8–16	TC20DF-V			
	12–18	TC20DF-X			
TR-1SN/3	13–20	TR26DW-X			Manual and auto 1NO+1NC
	20–26	TR26DW-Y			
TR-2NF/3	12–18	TR35DW-X	28–40	TR35DW-F	Manual and auto
	18–26	TR35DW-B	34–50	TR35DW-G	
	24–36	TR35DW-E			
TR-3N/3	24–36	TR65DW-E	34–50	TR65DW-G	Manual and auto
	28–40	TR65DW-F	45–67	TR65DW-J	

Notes: *1 2-element is also available on request.
*2 Auto reset type is available on request. Specify "Auto reset" when ordering.

Maximum setting ranges at 380–440V AC for starter use

TR-0/3	4–6A	TR-2N/3	18–26A (for FW-2S/3H)
RCa3737-1CNF/3	8–16A		34–50A (for FW-3/3H)
TR-1SN/3	13–20A	TR-3N/3	45–67A (for FW-4/3H)

■ **Characteristic curves (Cold start)**

TR-0/3

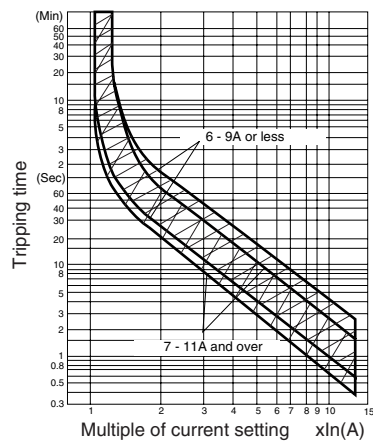

RCa3737-1CNF/3

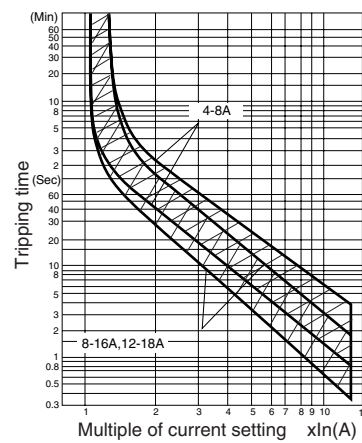

TR-1SN/3

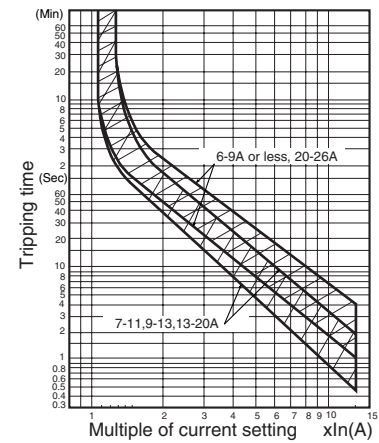

TR-2NF/3

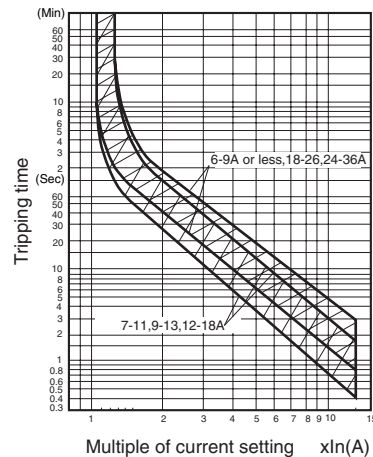

TR-3N/3

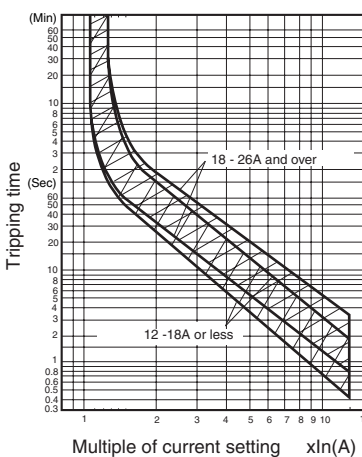

Magnetic Contactors and Starters

FW series

With pushbuttons

Magnetic motor starters with pushbuttons

Up to 4.5kW 440 Volts 3-phase

■ Description

FW series magnetic motor starter is provided with square-shaped ON-OFF pushbuttons. Internal wirings are connected. The starter is housed in a plastic enclosure (FW-0P/3H) or steel enclosure (FW-0PB/3H, 1PB/3H). The two operating buttons are color-coded; green for ON and red for OFF. Thermal overload relay is fitted with 2 or 3-element and is of manual reset type.

■ Ordering information

Specify the following:

1. Ordering code
 2. Operating coil voltage
 3. Main circuit voltage.
 4. Overload relay setting range code
- See page 01/95.

■ Performance data

Same as FW series. See page 01/93.

■ Characteristic curves (Cold start)

See page 01/95.

■ Thermal overload relay

Type	Setting range (A)	Contact	Starter type
TR-0 (2 or 3-element)	0.24–0.36, 0.48–0.72, 0.8–1.2, 0.95–1.45 1.4–2.2, 1.7–2.6, 2.8–4.2, 4–6, 5–8, 6–9 7–11, 9–13	SPDT 95 — 96 — 98	FW-0P, FW-0P/3H, FW-0PL, FW-0PL/3H, FW-0SP, FW-0SP/3H FW-0PB, FW-0PB/3H, FW-0SPB, FW-0SPB/3H
RCa3737-1CNF (2 or 3-element)	4–8, 8–16, 12–18	SPDT 21 — 22 — 23	FW-1PB, FW-1PB/3H

Note: Maximum setting ranges at 440V AC for starter use:
TR-0: 4-6A, RCa3737-1CNF: 8-16A

■ Dimensions, mm

FW-0P, 0PL, 0SP, 0SPL

Plastic enclosure

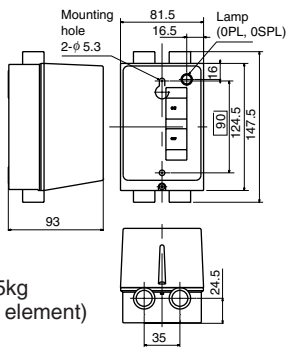

Mass: 0.45kg
(3-thermal element)

FW-0PB, 0SPB

Steel enclosure

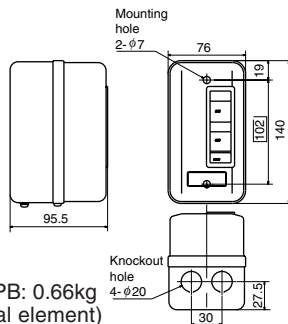

Mass: 0PB: 0.66kg
(3-thermal element)

FW-1PB

Steel enclosure

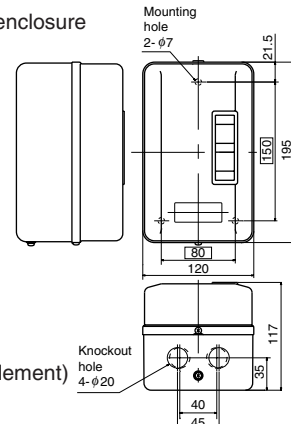

Mass: 1.5kg
(3-thermal element)

■ Wiring diagrams

FW-0P/3H, 0PL/3H, 0SP/3H, 0SPL/3H

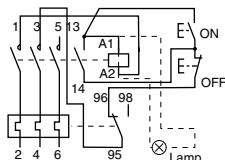

FW-0PB/3H, 0SPB/3H

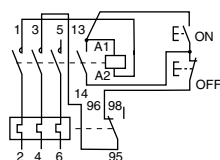

FW-1PB/3H

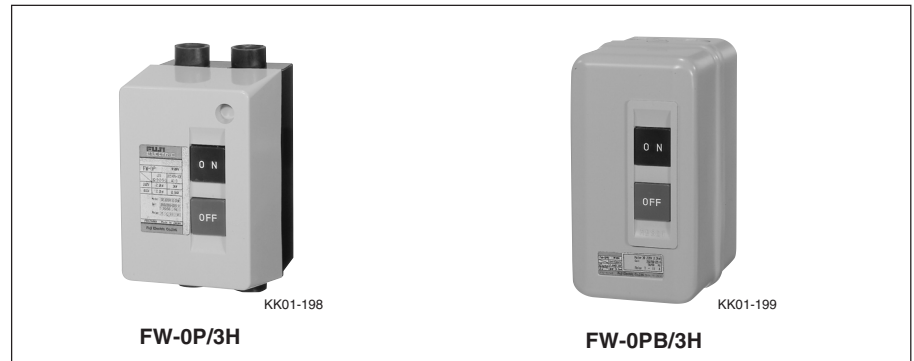
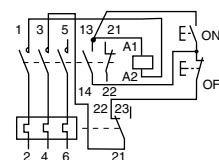

■ Types and ratings

Max. motor capacity (kW) 3-phase 200- 380- 240V 440V	Operational current (A) 200- 380- 240V 440V	2-thermal element		3-thermal element	
		Type	Ordering code	Type	Ordering code
3.0 2.5	12 6	FW-0P	SF12BPAN-■10T□	FW-0P/3H	SF12BPAN-■10T□D
3.5 4.5	15 10	FW-0SP	SF15BPAN-■10T□	FW-0SP/3H	SF15BPAN-■10T□D
3.0 2.5	12 6	FW-0PB	SF12BSAN-■10T□	FW-0PB/3H	SF12BSAN-■10T□D
3.5 4.5	15 10	FW-0SPB	SF15BSAN-■10T□	FW-0SPB/3H	SF15BSAN-■10T□D
5.5 5.5	20 13	FW-1PB	SF20BSAN-■11T□	FW-1PB/3H	SF20BSAN-■11T□D
3.0 2.5	12 6	FW-0PL	SF12BKAN-■10T□	FW-0PL/3H	SF12BKAN-■10T□D
3.5 4.5	15 10	FW-0SPL	SF15BKAN-■10T□	FW-0SPL/3H	SF15BKAN-■10T□D

Notes; Auxiliary contact 1NC is available on request. (0P, 0PB)

Conforming to IEC 60947-4-1 AC-3.

■: Enter the operating coil voltage code.

□: Enter the thermal overload relay ampere setting range code.